

Article number: 4320000801

Description: Rota-fix shaft-hub connection A 80x120  
Stainless Steel

## Measures

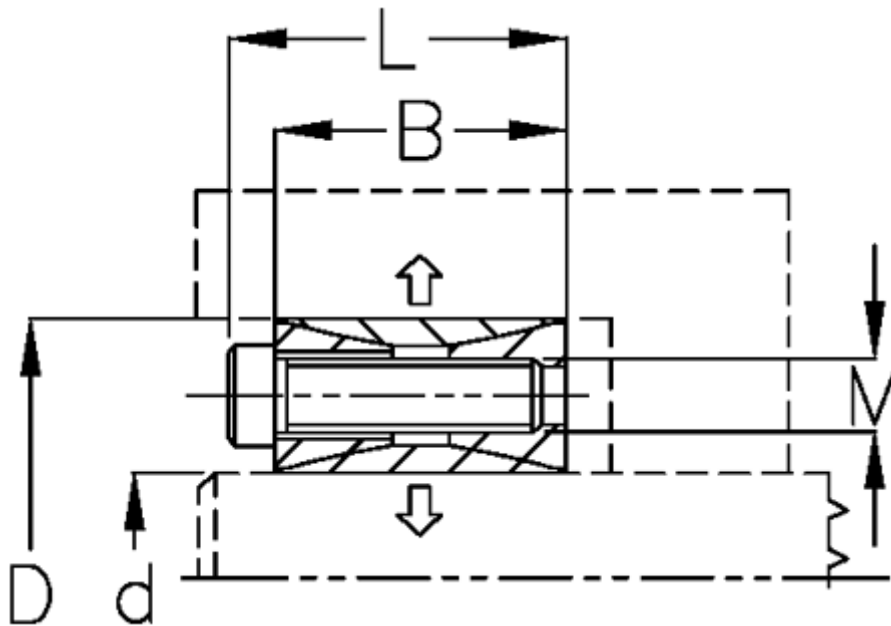

B mm	= 28
d H8 mm	= 80
D mm	= 120
Fit tolerance	= Aksel k11-h11, Nav N11-H11
F kN torque	= 83.6
L mm	= 38
M mm	= M10
P N/mm <sup>2</sup> surface pressure on shaft/hub	= 47

Surface roughness	=
T N m torque	=
Ts N m bolt tightening torque	=